



Scheda Tecnica - Technical Sheet

Adattatore triplo

Triple adapter plug



Art.
300613B
300613N

**Adattatore triplo
Schuko
2P+T 16A~ 250V
2P+T 10/16A~ 250V
+ schuko**

Dimensioni:
Size: **45x48x74 mm**

**Spina 2P+T 16A~ 250V
2x Presa 2P+T 10/16A~ 250V
+ Schuko**
*Plug 2P+T 16A~ 250V
2x socket 2P+T 10/16 A~ 250V
+ Schuko*

Colori: Bianco - Nero
Colours: White - Black

**Corpo in polimero
Potenza max 1500W
Spinotti in ottone nichelato
Prese grado prot. 2.1**
*Polymer body
Max power 1500W
Nickel-plated brass pins
Sockets with protection 2.1*



Certificazione IMQ

**NORME: CEI 23-50
CEI 23-57**



Scatolo con stampa in quadricromia
Giftbox 4 colours



Etichetta
Label

10 pezzi per ogni busta
Bag 10 pieces

Scatolo contiene 5 buste trasparente da 10 pezzi
Giftbox contain 5 transparent bag with 10 pieces

Busta trasparente
Transparent bag



Etichetta
Label

Export Carton/PCS

Bar Code:
Position 4 sides
in the upper left



Lateral Sides
Shipping Mark:

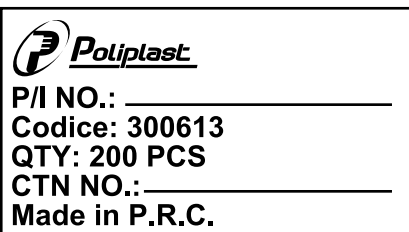

Central Sides
Shipping Mark:

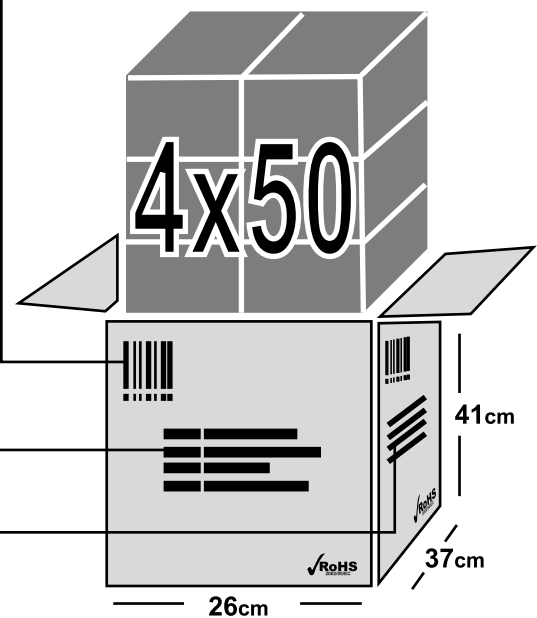
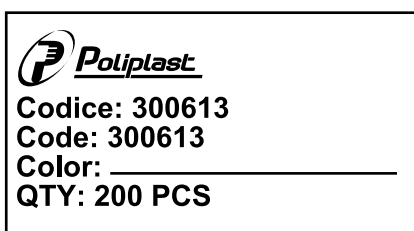

Presa bivalente 10/16A
Bivalent socket 10/16A

Presa con alveoli
 con grado di protezione 2.1
Socket with protection 2.1

Corpo in polimero
Polymer body

Corpo in polimero
Polymer body

Presa Schuko
Schuko socket

Frutto con spinotti in ottone nichelato
Nickel-plated brass pins

Frutto con spinotti in ottone nichelato
Nickel-plated brass pins

Misure
Measures

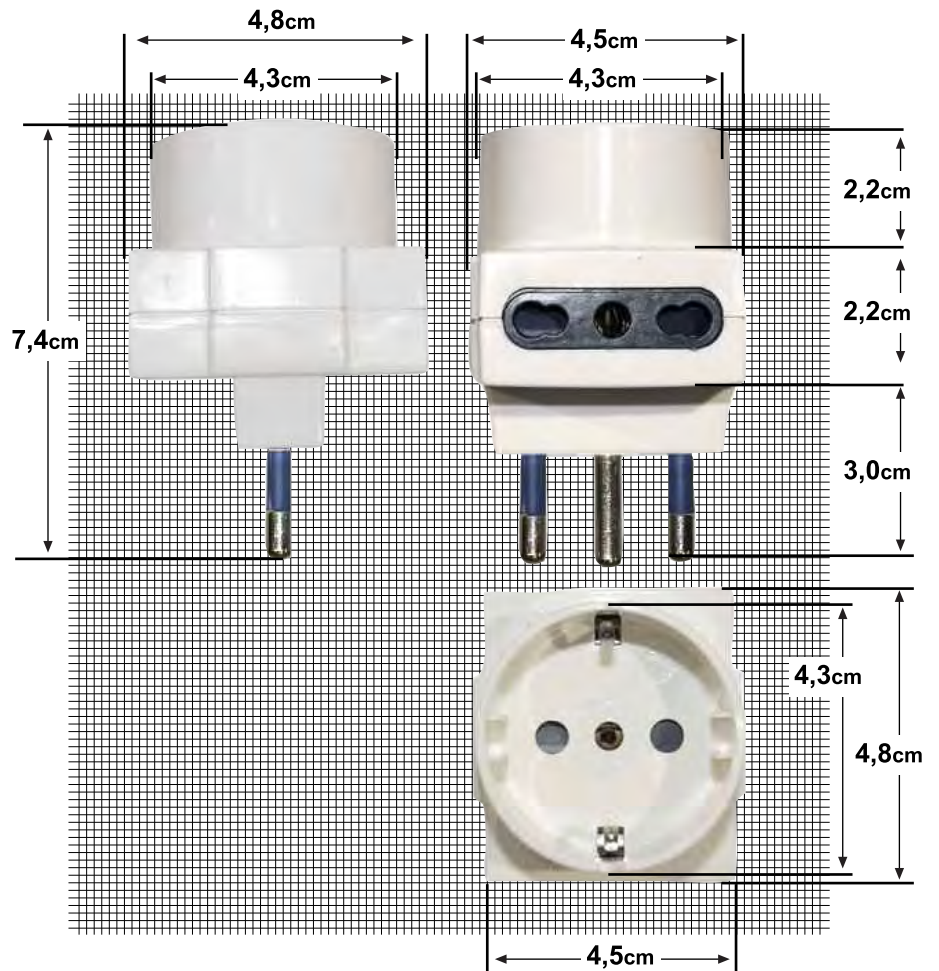
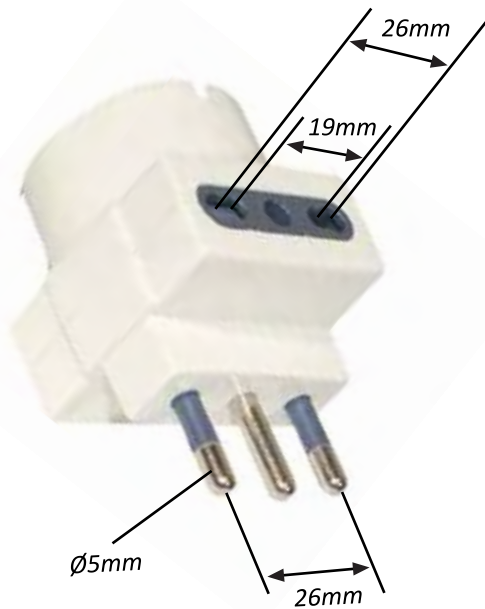

Art. 300613N
70x50 mm

Etichetta per lo scatolo
Label for box

Codice: 300613N
 Colore: 
 Adattatore triplo Schuko
 Spina 2P+T 16A 250V~
 Presa 2P+T 10/16A 250V~
 + Schuko
 Norme: CEI 23-50 CEI 23-57 **Pezzi: 50**

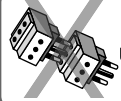
Non inserire
un adattatore
in un altro



8 032706 127493
Made in P.C.R.

Art. 300613B
70x50 mm

Etichetta per lo scatolo
Label for box

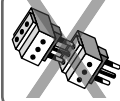

Codice: 300613B
 Colore: 
 Adattatore triplo Schuko
 Spina 2P+T 16A 250V~
 Presa 2P+T 10/16A 250V~
 + Schuko
 Norme: CEI 23-50 CEI 23-57 **Pezzi: 50**

Non inserire
un adattatore
in un altro



8 032706 127486
Made in P.C.R.

Codice: 300613N
 Colore: Nero
 Adattatore triplo Schuko
 Spina 2P+T 16A 250V~
 Presa 2P+T 10/16A 250V~
 + Schuko
 Norme: CEI 23-50
 CEI 23-57
Pezzi: 10

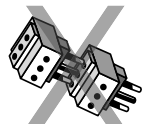

Non inserire
un adattatore
in un altro



8 032706 127493
Made in P.C.R.

85x40 mm

Etichetta per la busta
Label for bag

Codice: 300613B
 Colore: Bianco
 Adattatore triplo Schuko
 Spina 2P+T 16A 250V~
 Presa 2P+T 10/16A 250V~
 + Schuko
 Norme: CEI 23-50
 CEI 23-57
Pezzi: 10

Non inserire
un adattatore
in un altro

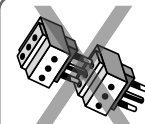

8 032706 127486
Made in P.C.R.

85x40 mm

Etichetta per la busta
Label for bag



IMQ S.p.A. Società a Socio Unico
I-20138 Milano - via Quintiliano, 43
tel. 0250731(r.a.) - fax 0250991500
e-mail: info@imq.it - www.imq.it

Rea Milano 1595884
Registro Imprese MI 12898410159
C.F./P.I. 12898410159
Capitale Sociale € 4.000.000

CA02.03814
SN.J000D3

PID:
02114000
CID:
CN.F00089

Certificato di approvazione
Approval certificate

IMQ, ente di certificazione accreditato, autorizza la ditta *IMQ, accredited certification body, grants to*

POLIPLAST SRL
ZONA INDUSTRIALE 13esima STRADA N. 34-36
95121 CATANIA CT

all'uso del marchio

the licence to use the mark

IMQ

Il presente certificato è soggetto alle condizioni previste nel Regolamento "MARCHI IMQ - Regolamento per la certificazione di prodotti" ed è relativo ai prodotti descritti nell'Allegato al presente certificato.



per i seguenti prodotti

for the following products

Adattatori per uso domestico
(Rif. di tipo 300613)

Adaptors for domestic purposes
(Type ref. 300613)

This certificate is subjected to the conditions foreseen by Rules "IMQ MARKS - RULES for product certification" and is relevant to the products listed in the annex to this certificate.

Emesso il | Issued on **2009-04-22**
Aggiornato il | Updated on **2014-10-20**
Sostituisce | Replaces **2010-02-16**

Augusto Cicchi
IMQ S.p.A.

